



1x
42003, 10



2x
32449, 3



1x
6589, 9



1x
6536, 7

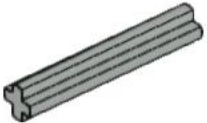

2x
4519, 9



1x
32269, 9



2x
32062, 5

1

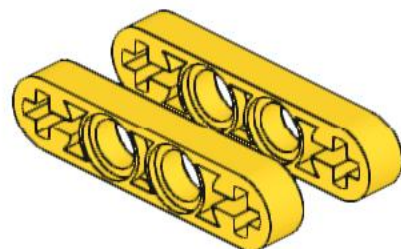
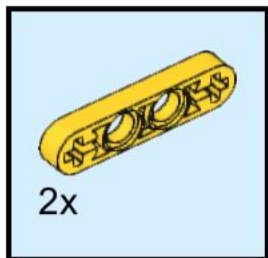

2

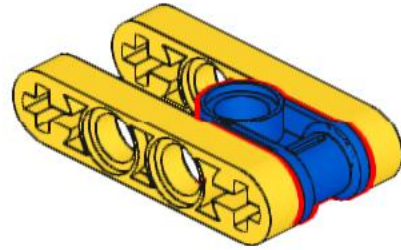
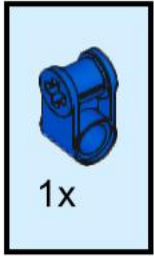

3

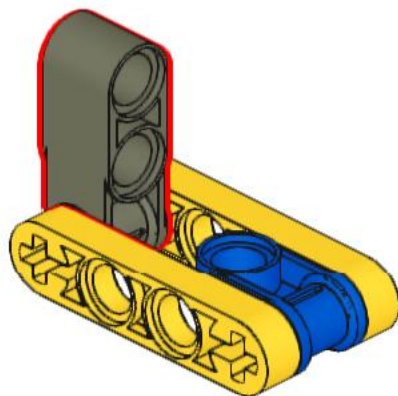
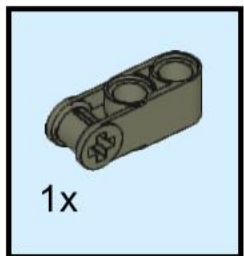

4

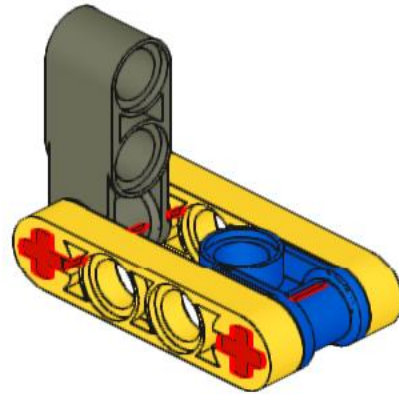
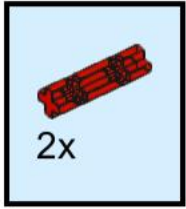

5

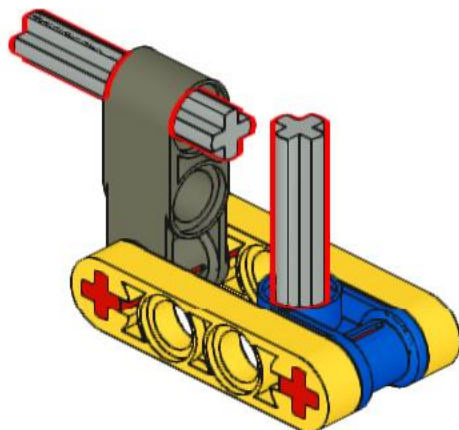
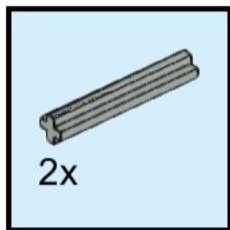

6

