

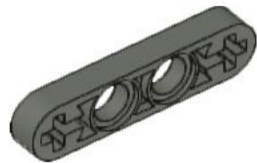

9x
2780, 11

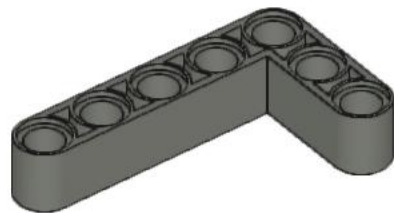

5x
32449, 85



2x
32526, 85



1x
4519, 9



1x
6538b, 11



1x
87083, 85



1x
32184, 9



1x
32138, 11

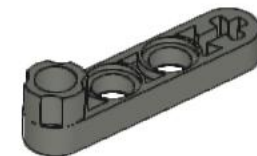

1x
2825, 85

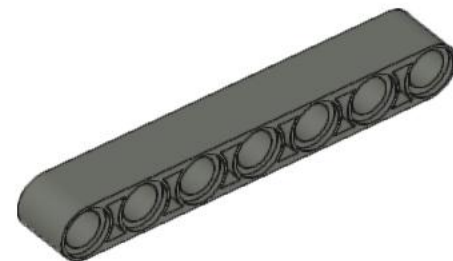

1x
32524, 85

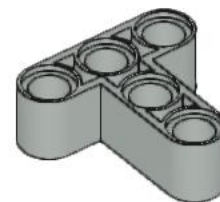

1x
60484, 9

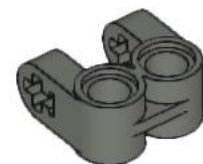

2x
41678, 85

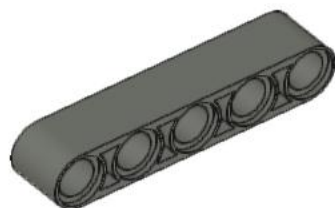

1x
32316, 85



2x
3647, 9

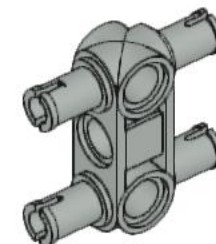

1x
48989, 9

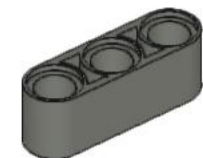

3x
32523, 85

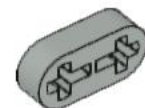

8x
41677, 9

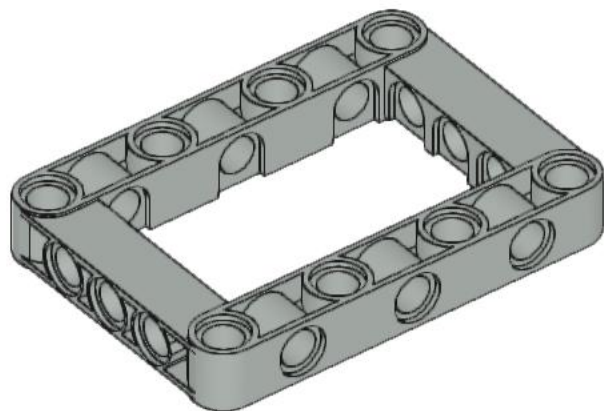

3x
6558, 109

1x
64179, 9



7x
32062, 27



1x
32013, 150



2x
43093, 109

1

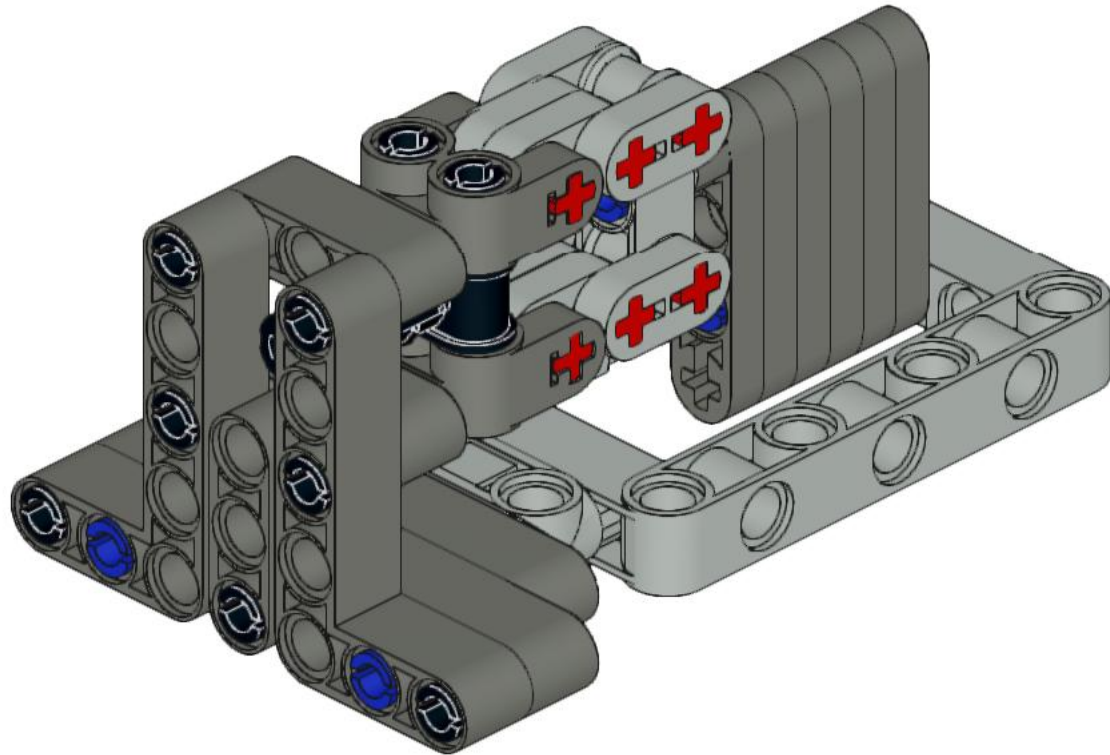
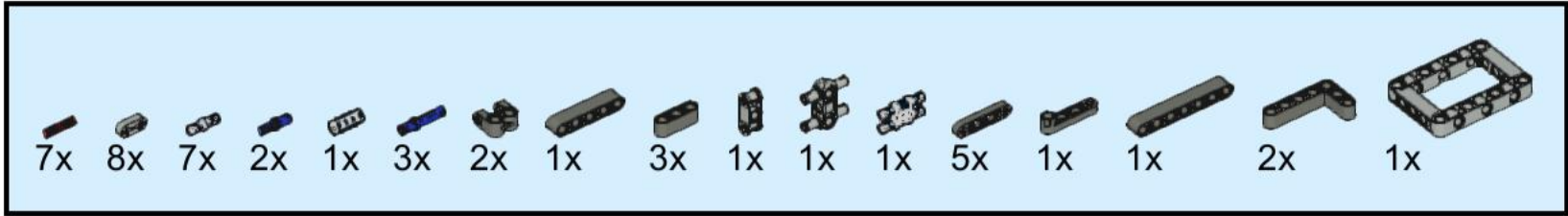

2

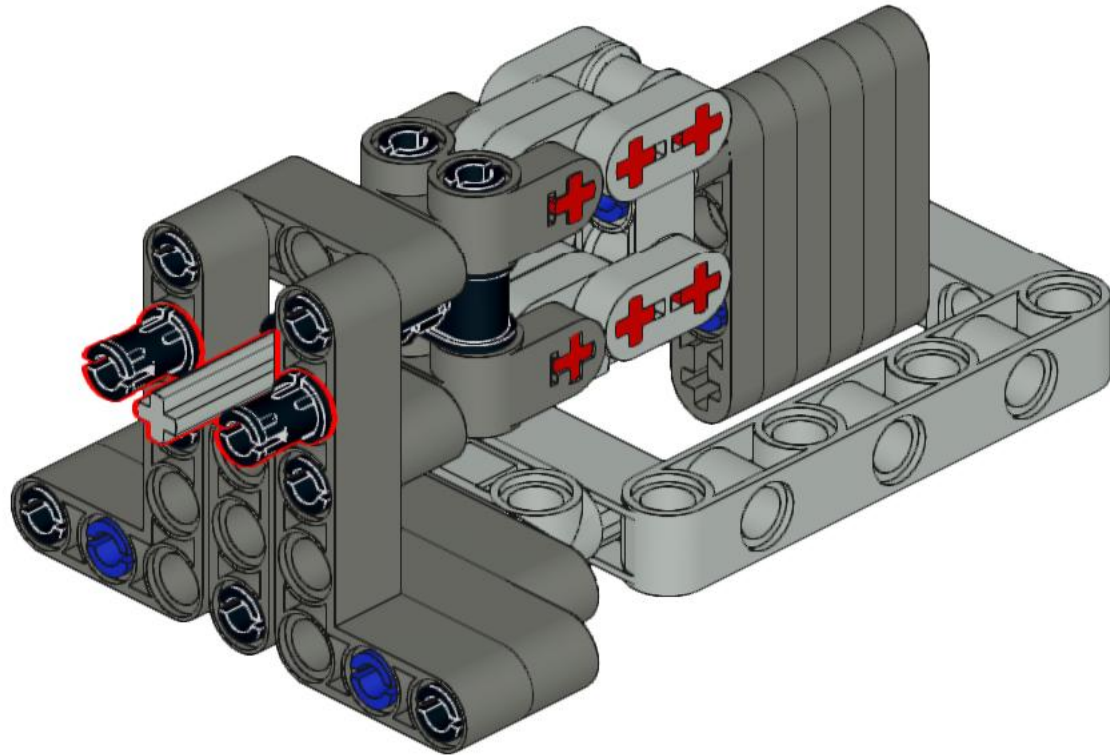
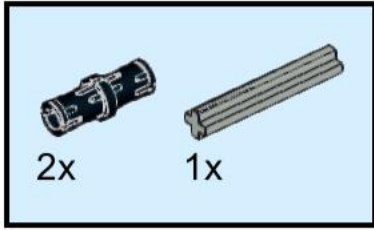

3

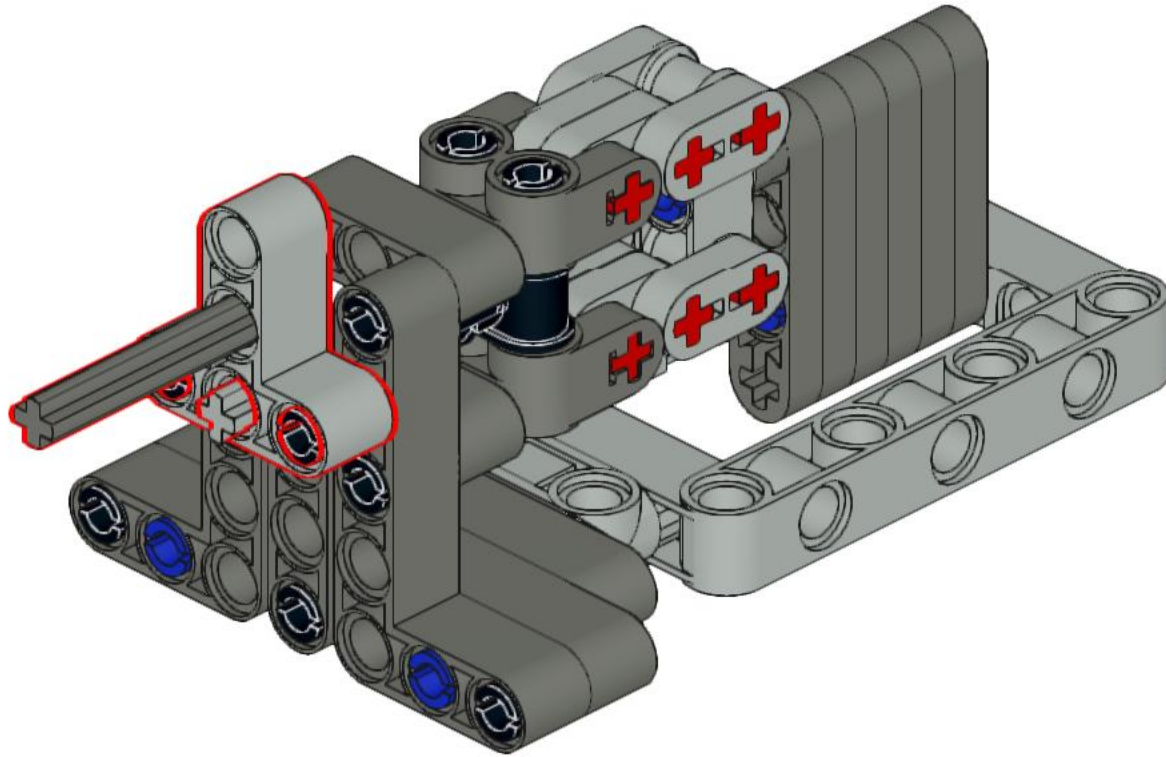
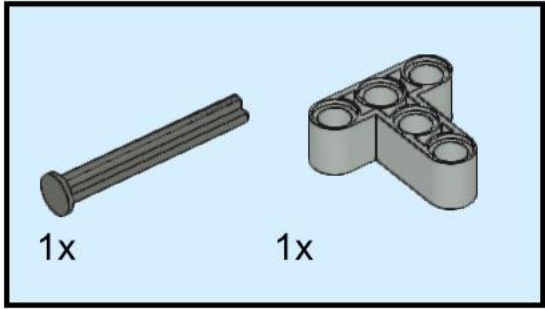

4

